

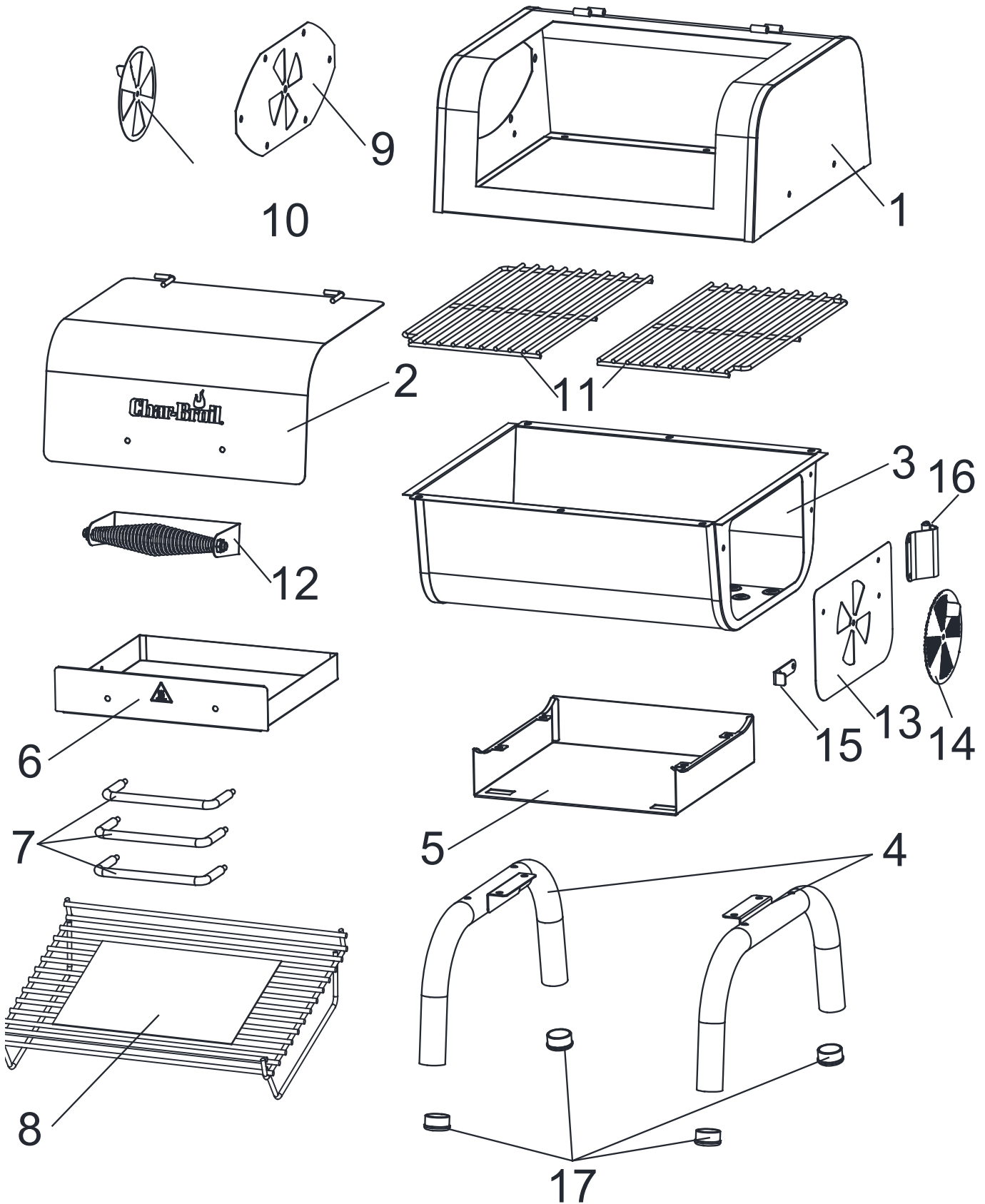





# REPLACEMENT PARTS DIAGRAM • DIAGRAMA DE PIEZAS DE REPUESTO

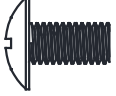

# REPLACEMENT PARTS LIST

Key	Qty	Description
1	1	FIREBOX TOP
2	1	TOP LID
3	1	FIREBOX BOTTOM
4	2	SUPPORT LEG
5	1	ASH PAN SUPPORT
6	1	ASH PAN
7	3	HANDLE
8	1	FIRE GRATE
9	1	SIDE PLATE, FIREBOX TOP
10	1	DAMPER F/ FIREBOX TOP
11	2	COOKING GRATE
12	1	LID HANDLE
13	1	SIDE DOOR, FIREBOX BOTTOM
14	1	DAMPER F/ SIDE DOOR
15	1	LATCH, F/ SIDE DOOR
16	1	HINGE, F/ SIDE DOOR
17	4	LEG CAP
<b>NOT Shown</b>		
...	1	HARDWARE PACK
...	1	PRODUCT GUIDE

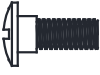
# HARDWARE LIST

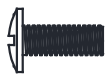
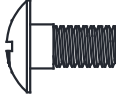
Key	Description	Image	Quantity
A	1/4-20×1/2"Screw		18
B	1/4-20×1 3/4"Screw		4
C	1/4-20 Flange Nut		21
D	1/4-20 Locking Nut		2
E	#10-24 Flange nut		5
F	10-24×2/5"Shoulder Bolt		1
G	10-24 Flat Washer		4
H	10-24 Lock Washers		4
J	10-24×1/2"Screw		4
K	1/4-20×1/2" Shoulder Bolt		1